

YAMAHA DSP-E390

Natural Sound Digital Sound Field Processor

4 Programs for Digital Sound Field Processing

2 Programs for Dolby Surround (DOLBY PRO LOGIC and ENHANCED)

60W (8Ω) RMS Output Power, 0.1% THD, 1 kHz (Center Channel Power Amplifier)

15W + 15W (8Ω) RMS Output Power, 0.7% THD, 1 kHz (Rear Channel Power Amplifier)

Automatic Input Balance Control for Dolby Surround

Test Tone Generator for Easier Speaker Balance Adjustment

3 Center Channel Modes (NORMAL/WIDE/PHANTOM)

Remote Control Capability

Thank you for selecting this YAMAHA digital sound field processor.



OWNER'S MANUAL

CONTENTS

Safety Instructions	2
Supplied Accessories	3
Profile of This Unit	4
Speaker Setup	5
Connections	6
Identification of Controls	9
Speaker Balance Adjustment	10
Using Digital Sound Field Processor (DSP)	12
Notes about the Remote Control Transmitter	15
Troubleshooting	16
Specifications	16

IMPORTANT!

Please record the serial number of this unit in the space below.

Serial No.:

The serial number is located on the rear of the unit.
Retain this Owner's Manual in a safe place for future reference.

WARNING

TO REDUCE THE RISK OF FIRE OR ELECTRIC SHOCK, DO NOT EXPOSE THIS UNIT TO RAIN OR MOISTURE.

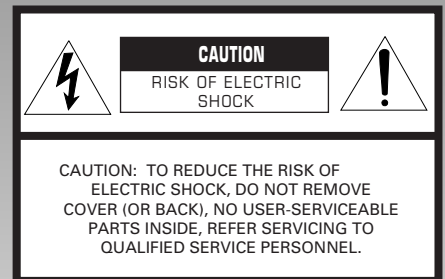

• Explanation of Graphical Symbols



The lightning flash with arrowhead symbol, within an equilateral triangle, is intended to alert you to the presence of uninsulated "dangerous voltage" within the product's enclosure that may be of sufficient magnitude to constitute a risk of electric shock to persons.



The exclamation point within an equilateral triangle is intended to alert you to the presence of important operating and maintenance (servicing) instructions in the literature accompanying the appliance.

SAFETY INSTRUCTIONS

- 1 Read Instructions – All the safety and operating instructions should be read before the unit is operated.
- 2 Retain Instructions – The safety and operating instructions should be retained for future reference.
- 3 Heed Warnings – All warnings on the unit and in the operating instructions should be adhered to.
- 4 Follow Instructions – All operating and other instructions should be followed.
- 5 Water and Moisture – The unit should not be used near water – for example, near a bathtub, washbowl, kitchen sink, laundry tub, in a wet basement, or near a swimming pool, etc.
- 6 Carts and Stands – The unit should be used only with a cart or stand that is recommended by the manufacturer.
- 6A A unit and cart combination should be moved with care. Quick stops, excessive force, and uneven surfaces may cause the unit and cart combination to overturn. 
- 7 Wall or Ceiling Mounting – The unit should be mounted to a wall or ceiling only as recommended by the manufacturer.
- 8 Ventilation – The unit should be situated so that its location or position does not interfere with its proper ventilation. For example, the unit should not be situated on a bed, sofa, rug, or similar surface, that may block the ventilation openings; or placed in a built-in installation, such as a bookcase or cabinet that may impede the flow of air through the ventilation openings.
- 9 Heat – The unit should be situated away from heat sources such as radiators, stoves, or other appliances that produce heat.
- 10 Power Sources – The unit should be connected to a power supply only of the type described in the operating instructions or as marked on the unit.
- 11 Power-Cord Protection – Power-supply cords should be routed so that they are not likely to be walked on or pinched by items placed upon or against them, paying particular attention to cords at plugs, convenience receptacles, and the point where they exit from the unit.
- 12 Cleaning – The unit should be cleaned only as recommended by the manufacturer.
- 13 Nonuse Periods – The power cord of the unit should be unplugged from the outlet when left unused for a long period of time.
- 14 Object and Liquid Entry – Care should be taken so that objects do not fall into and liquids are not spilled into the inside of the unit.
- 15 Damage Requiring Service – The unit should be serviced by qualified service personnel when:
 - A. The power-supply cord or the plug has been damaged; or
 - B. Objects have fallen, or liquid has been spilled into the unit; or
 - C. The unit has been exposed to rain; or
 - D. The unit does not appear to operate normally or exhibits a marked change in performance; or
 - E. The unit has been dropped, or the cabinet damaged.
- 16 Servicing – The user should not attempt to service the unit beyond those means described in the operating instructions. All other servicing should be referred to qualified service personnel.
- 17 Power Lines – An outdoor antenna should be located away from power lines.
- 18 Grounding or Polarization – Precautions should be taken so that the grounding or polarization is not defeated.

Caution: Read this before operating your unit

- 1 To assure the finest performance, please read this manual carefully. Keep it in a safe place for future reference.
- 2 Install this unit in a cool, dry, clean place – away from windows, heat sources, sources of excessive vibration, dust, moisture and cold. Avoid sources of humming (transformers, motors). To prevent fire or electrical shock, do not expose the unit to rain and water.
- 3 Do not operate the unit upside-down. It may overheat, possibly causing damage.
- 4 Never open the cabinet. If something drops into the set, contact your dealer.
- 5 Do not use force on switches, controls or connection wires. When moving the unit, first disconnect the power plug and the wires connected to other equipment. Never pull the wires themselves.
- 6 The openings on the cabinet assure proper ventilation of the unit. If these openings are obstructed, the temperature inside the cabinet will rise rapidly and eventually damage the circuits. Therefore, avoid placing objects against these openings and do not install the unit where the flow of air through the ventilation openings could be impeded.
- 7 Do not attempt to clean the unit with chemical solvents; this might damage the finish. Use a clean, dry cloth.
- 8 Always set the VOLUME control to “– ∞” before starting the audio source play: increase the volume gradually to an appropriate level after the play back has been started.
- 9 To prevent lightning damage, pull out the power cord during an electrical storm.
- 10 Be sure to read the “TROUBLESHOOTING” section regarding common operating errors before concluding that the unit is faulty.
- 11 AC outlet
Do not connect audio equipment to the AC outlet on the rear panel if that equipment requires more power than the outlet is rated to provide.

FCC INFORMATION

1. IMPORTANT NOTICE : DO NOT MODIFY THIS UNIT!

This product, when installed as indicated in the instructions contained in this manual, meets FCC requirements. Modifications not expressly approved by Yamaha may void your authority, granted by the FCC, to use the product.

2. IMPORTANT : When connecting this product to accessories and/or another product use only high quality shielded cables. Cable/s supplied with this product MUST be used. Follow all installation instructions. Failure to follow instructions could void your FCC authorization to use this product in the USA.

3. NOTE : This product has been tested and found to comply with the requirements listed in FCC Regulations, Part 15 for Class "B" digital devices. Compliance with these requirements provides a reasonable level of assurance that your use of this product in a residential environment will not result in harmful interference with other electronic devices.

This equipment generates/uses radio frequencies and, if not installed and used according to the instructions found in the users manual, may cause interference harmful to the operation of other electronic devices.

Compliance with FCC regulations does not guarantee that interference will not occur in all installations. If this product is found to be the source of interference, which can be determined by turning the unit "OFF" and "ON", please try to eliminate the problem by using one of the following measures:

Relocate either this product or the device that is being affected by the interference.

Utilize power outlets that are on different branch (circuit breaker or fuse) circuits or install AC line filter/s.

In the case of radio or TV interference, relocate/reorient the antenna. If the antenna lead-in is 300 ohm ribbon lead, change the lead-in to coaxial type cable.

If these corrective measures do not produce satisfactory results, please contact the local retailer authorized to distribute this type of product. If you can not locate the appropriate retailer, please contact Yamaha Electronics Corp., U.S.A. 6660 Orangethorpe Ave, Buena Park, CA 90620.

The above statements apply ONLY to those products distributed by Yamaha Corporation of America or its subsidiaries.

We Want You Listening For A Lifetime

YAMAHA and the Electronic Industries Association's Consumer Electronics Group want you to get the most out of your equipment by playing it at a safe level. One that lets the sound come through loud and clear without annoying blaring or distortion – and, most importantly, without affecting your sensitive hearing. Since hearing damage from loud sounds is often undetectable until it is too late, YAMAHA and the Electronic Industries Association's Consumer Electronics Group recommend you to avoid prolonged exposure from excessive volume levels.



SUPPLIED ACCESSORIES

After unpacking, check that the following parts are contained.

- Remote Control Transmitter

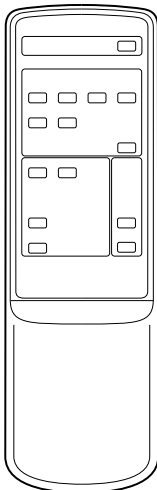

- Batteries (size AA, R6, UM-3)

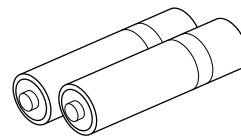

- Audio connection cord x 2

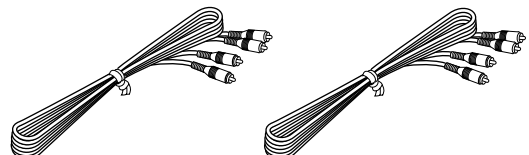

PROFILE OF THIS UNIT

You are the proud owner of Yamaha DSP-E390 – an extremely sophisticated audio component. The Digital Sound Field Processor (DSP) built into this unit takes full advantage of Yamaha's undisputed leadership in the field of digital audio processing to bring you a whole new world of listening experiences. Follow the instructions in this manual carefully when setting up your system, and this unit will sonically transform your room into a totally new listening environment –movie theater, concert hall, and so on. In addition, you get incredible realism from Dolby Surround-encoded video sources using the built-in Dolby Pro Logic Surround Decoder. Please read this operation manual carefully and store it in a safe place for later reference.

Digital Sound Field Processing

What is it that makes live music so good? Today's advanced sound reproduction technology lets you get extremely close to the sound of a live performance, but chances are you'll still notice something missing: the acoustic environment of the live concert hall. Extensive research into the exact nature of the sonic reflections that create the ambience of a large hall has made it possible for Yamaha engineers to bring you this same sound in your own listening room, so you'll feel all the sound of a live concert.

Furthermore, our technicians, armed with sophisticated measuring equipment, have even made it possible to capture the acoustics of a variety of venues such as an actual concert hall, theater, etc. to allow you to accurately recreate one of several live performance environments in your own home.

Dolby Pro Logic Surround

The Dolby Pro Logic Surround Decoder program lets you experience the dramatic realism and impact of a Dolby Surround movie theater sound in your own home. Dolby Pro Logic gets its name from its professional-grade steering logic circuitry, which provides greater effective front and rear channel separation for a much higher degree of realism than the "passive" Dolby Surround circuits found in less sophisticated home audio/video equipment. Dolby Pro Logic Surround provides a true center channel, so there are four independent channels, unlike passive Dolby Surround which has in effect only three channels: left, right, and rear. This center channel allows listeners seated in even less-than-ideal positions to hear the dialog originating from action on the screen while getting a stereo effect as well.

This Dolby Pro Logic Surround Decoder employs a digital signal processing system. This system increases sound stability at each channel and minimizes crosstalk between channels compared to conventional analog Dolby signal processing.

In addition, this unit features a built-in automatic input balance control. This circuit always presents you the best surround conditions without performing manual adjustments.

Dolby Pro Logic Surround + DSP

You can also enjoy a combination of Dolby Pro Logic Surround and DSP in the sound field program "  PRO LOGIC ENHANCED".

It recreates the surround effect of a movie theater, effectively duplicating its multiple surround loudspeaker system, completely surrounding the listener with the sounds of the action taking place on the screen.

SPEAKER SETUP

SPEAKERS TO BE USED

This unit is designed to provide the best sound-field quality with a 5 speaker configuration. The most effective speakers to use with this unit are front speakers, rear speakers and a center speaker. You may omit the center speaker. (Refer to the “**4-Speaker Configuration**” shown below.)

The front speakers are used for the main source sound plus the effect sounds. They will probably be the speakers from your present stereo system. The rear speakers are used for the effect and surround sounds, and the center speaker is for the center sounds (dialog etc.) within the Dolby Surround encoded programs. The center speaker needs to be equal in power to the front speakers, although the rear speakers should not be equal. However, all the speakers should have high enough power handling to accept the maximum output of this unit.

SPEAKER CONFIGURATION

5-Speaker Configuration

This configuration is the most effective and recommended one. In this configuration, the center speaker is necessary as well as the rear speakers. If the digital sound field program **DOLBY PRO LOGIC** or **DOLBY PRO LOGIC ENHANCED** is selected, conversations will be output from the center speaker and the ambience will be excellent.

- Set the center channel mode to the “**NORMAL**” or “**WIDE**” position. (For details, refer to page 10.)

4-Speaker Configuration

The center speaker is not used in this configuration. If the digital sound field program **DOLBY PRO LOGIC** or **DOLBY PRO LOGIC ENHANCED** is selected, the center sound is output from the left and the right front speakers. However, the sound effect of other programs can be the same as that of the 5-speaker configuration.

- Be sure to set the center channel mode to the “**PHANTOM**” position. (For details, refer to page 10.)

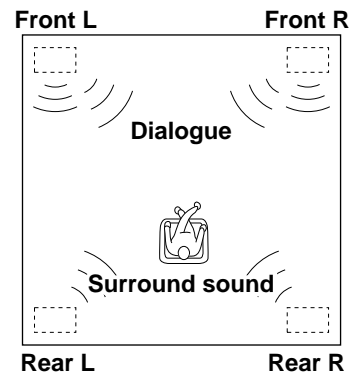
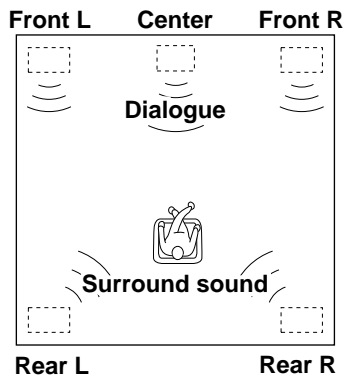

SPEAKER PLACEMENT

The recommended speaker configuration, the 5-speaker configuration, will require two speaker pairs: **front speakers** (your normal stereo speakers), and **rear speakers**, plus a **center speaker**. When you place these speakers, refer to the following.

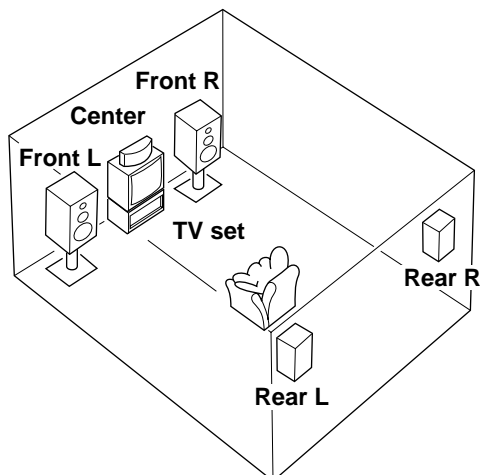

- Front:** In normal position. (The position of your present stereo speaker system.)
- Rear:** Behind your listening position, facing slightly inward. Nearly six feet (approx. 1.8 m) up from the floor.
- Center:** Precisely between the front speakers. (To avoid interference with TV sets, use a magnetically shielded speaker.)

CONNECTIONS

- Before attempting to make any connections to or from this unit, be sure to first switch OFF the power to this unit and to any other components to which connections are being made.
- When making connections between this unit and other components, be sure all connections are made correctly, that is to say L (left) to L, R (right) to R, “+” to “+” and “-” to “-”. Also, refer to the owner’s manual for each component to be connected to this unit.
- Choose one of the following three ways to connect this unit to your amplifier.

A Connecting to an Integrated Amplifier or Stereo Receiver with PRE OUT and MAIN IN terminals

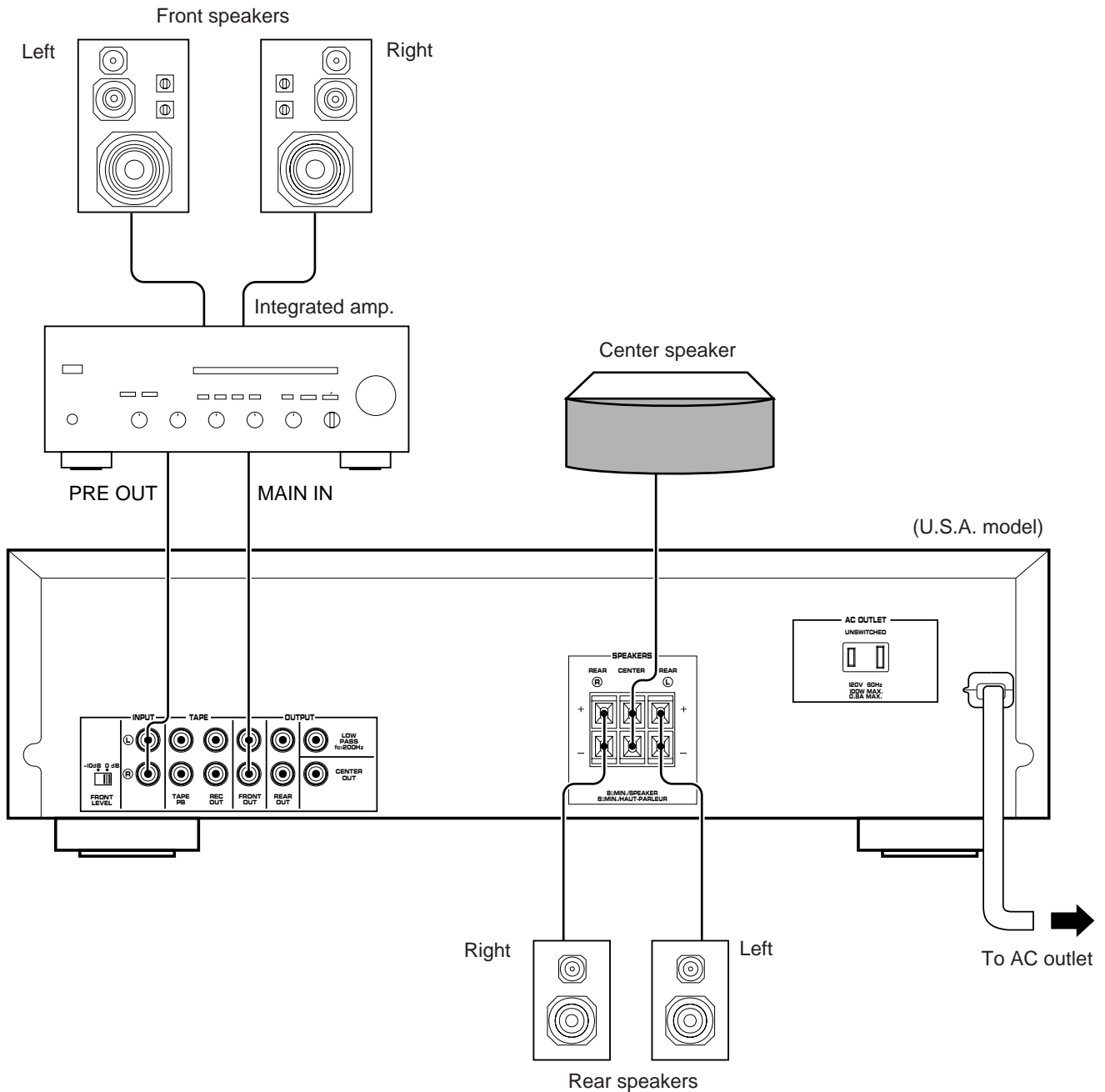

B Connecting to an Integrated Amplifier or Stereo Receiver that does not have PRE OUT and MAIN IN terminals

If your amplifier or receiver has the REC OUT selector which is independent of the input selector, connect this unit to the amplifier or receiver tape REC OUT and auxiliary (AUX) input terminals. If not, connect this unit to the amplifier or receiver tape REC OUT and TAPE PB terminals.

If your system includes a tape deck which have been displaced by connecting this unit to the tape REC OUT terminals, reconnect your tape deck to this unit's TAPE PB and TAPE REC OUT terminals.

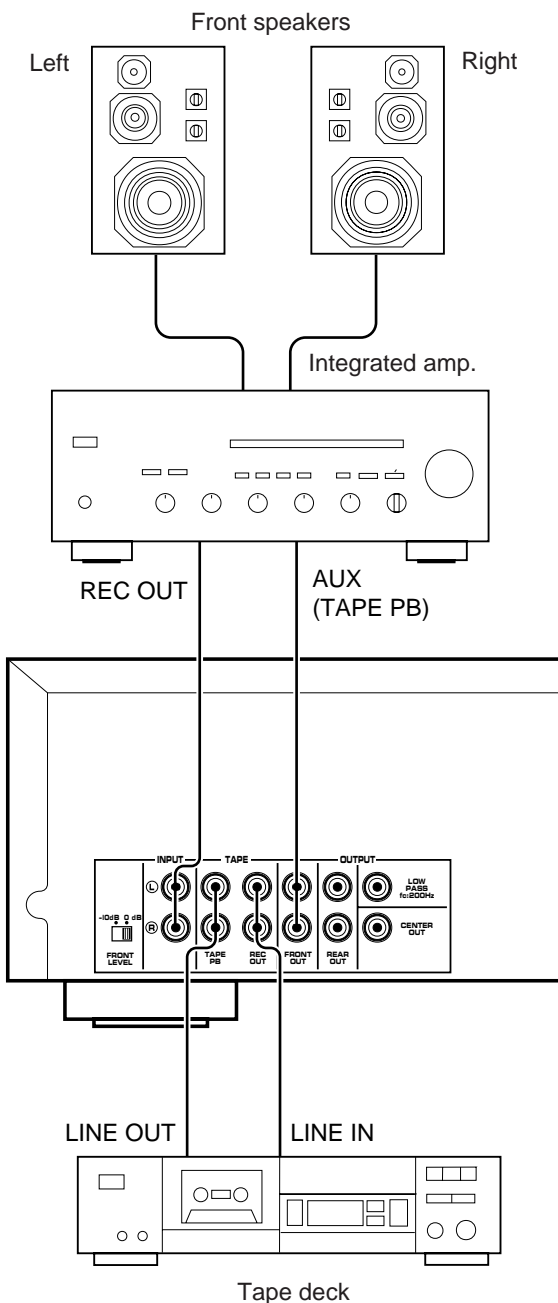

C Connecting to a Control Amplifier and Power Amplifier

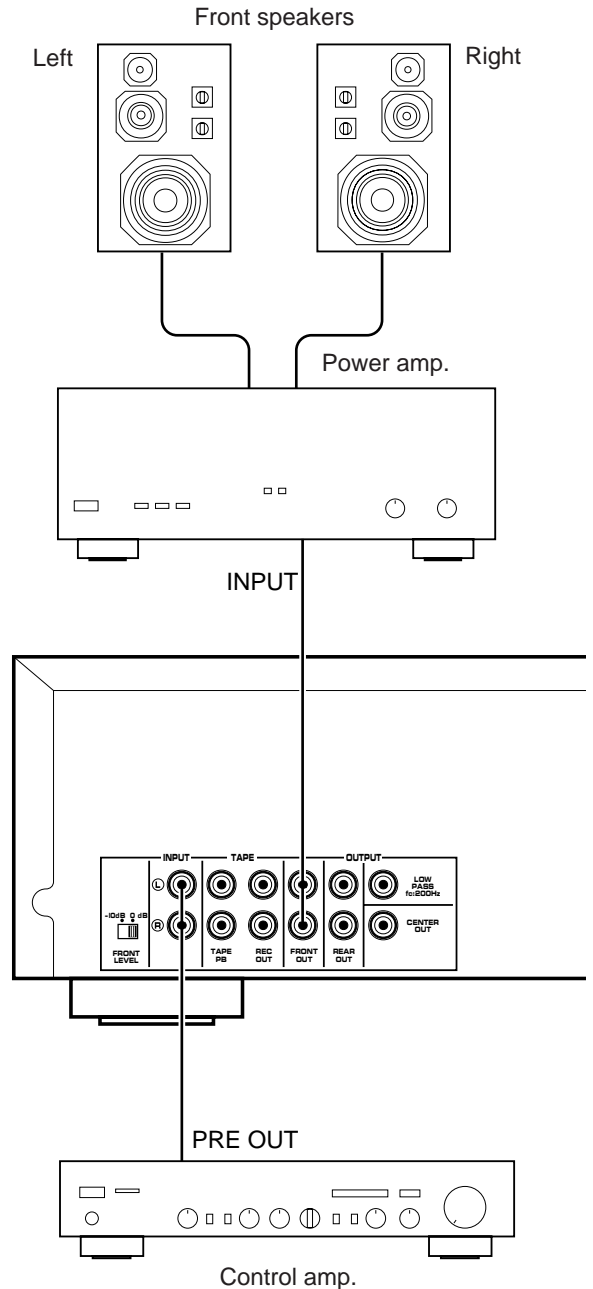

* For connecting the center speaker and the rear speakers, see the figure on the previous page.

CONNECTING SPEAKERS

Connect the **SPEAKERS** terminals to your speakers with wire of the proper gauge, cut as short as possible. If the connections are faulty, no sound will be heard from the speakers. Make sure that the polarity of the speaker wires is correct, that is, + and – markings are observed. If these wires are reversed, the sound will be unnatural and will lack bass. **Do not let the bare speaker wires touch each other and do not let them touch the metal parts of this unit as this could damage this unit and/or speakers.**

Note

Use speakers with the specified impedance shown on the rear of this unit.

Red: positive (+)
Black: negative (–)

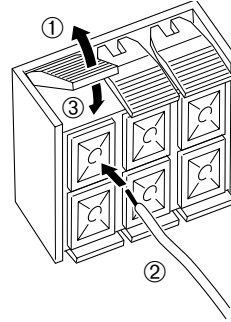

- ① Press and open the tab.
- ② Insert the bare wire.
[Remove approx. 5mm (1/4") insulation from the speaker wires.]
- ③ Press the tab back to the original position and secure the wire.

ABOUT THE ACCESSORY TERMINALS

AC OUTLET (UNSWITCHED)

This unswitched AC outlet can be used for connection of the power cord from another audio component. Note that the power to that component is not affected by the ON or OFF setting of the **POWER** switch of this unit.

Note: The maximum power (total power consumption of components) that can be connected here is 100 watts.

REAR OUTPUT terminals

These terminals are for rear channel line output. There is no connection to these terminals when you use the built-in amplifier.

However, if you drive rear speakers with an external stereo power amplifier, connect the input terminals of the external amplifier (MAIN IN or AUX terminals of a power amplifier or an integrated amplifier) to these terminals.

CENTER OUTPUT terminal

This terminal is for center channel line output. There is no connection to this terminal when you use the built-in amplifier. However, if you drive a center speaker with an external power amplifier, connect the input terminal of the external amplifier to this terminal.

LOW PASS terminal

This terminal is for output to a monaural amplifier driving a subwoofer. Only frequencies below 200 Hz from the front and center channels are output.

ADDING A SUBWOOFER

You may wish to add a subwoofer to reinforce the bass frequencies.

Connect the **LOW PASS** terminal to the INPUT terminal of the subwoofer amplifier, and connect the speaker terminals of the subwoofer amplifier to the subwoofer.

With some subwoofers, including the Yamaha Active Servo Processing Subwoofer System, the amplifier and subwoofer are in the same unit.

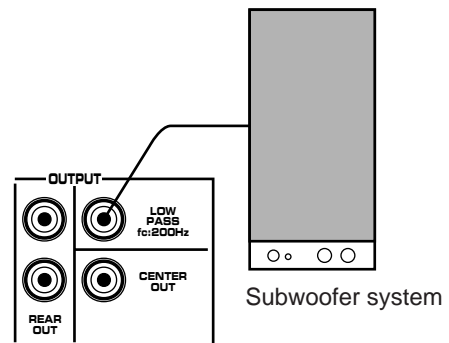

FRONT LEVEL switch

Normally set to "0 dB". If desired, you can decrease the output level at the **FRONT OUT** terminals by 10 dB by setting this switch to "–10 dB".

(Refer to "Notes" on page 11.)



IDENTIFICATION OF CONTROLS

FRONT PANEL

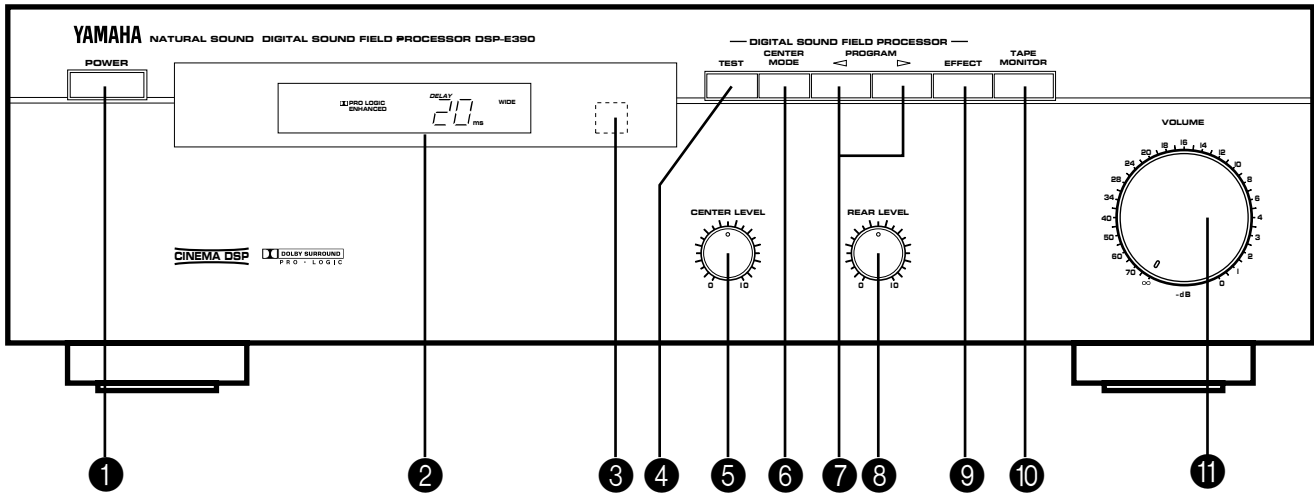

REMOTE CONTROL TRANSMITTER

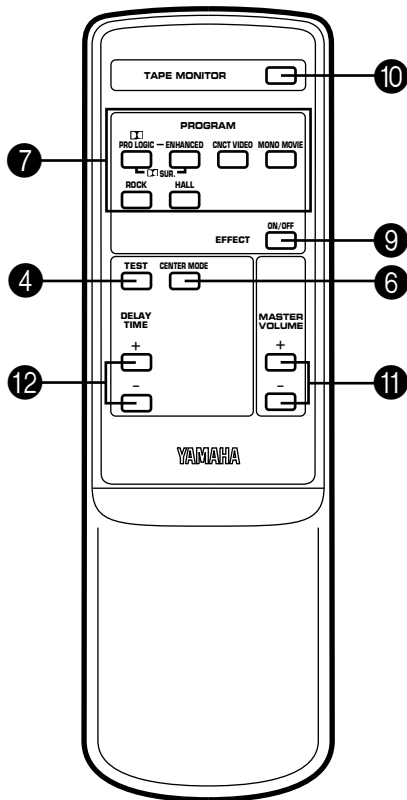

- 1 POWER**
Turns the power on/off.
- 2 Display panel**
Displays your selection on the DSP or other information.
- 3 Remote control sensor**
Receives signals from the remote control transmitter.
- 4 TEST**
Used for speaker balance adjustment. (See pages 10–11.)
- 5 CENTER LEVEL**
Adjusts center speaker sound output level. (See page 14.)
- 6 CENTER MODE**
Selects center channel output mode. (See page 10.)
- 7 PROGRAM**
Selects a program from the digital sound field processor. (See pages 12–14.)
- 8 REAR LEVEL**
Adjusts rear speaker sound output level. (See page 14.)
- 9 EFFECT ON/OFF**
Switches on/off the digital sound field processor. (See page 14.)
- 10 TAPE MONITOR**
Used when the tape deck is connected to this unit's TAPE terminals to select that tape as the input source. (See page 13.)
- 11 MASTER VOLUME**
Turns the master volume level up/down.
- 12 DELAY TIME**
Adjusts delay time. (See page 15.)

SPEAKER BALANCE ADJUSTMENT

This procedure lets you adjust the sound output level balance between the front, center, and rear speakers using the built-in test tone generator. When this adjustment is performed, the sound output level heard at the listening position will be the same from each speaker. This is important for the best performance of the digital sound field processor.

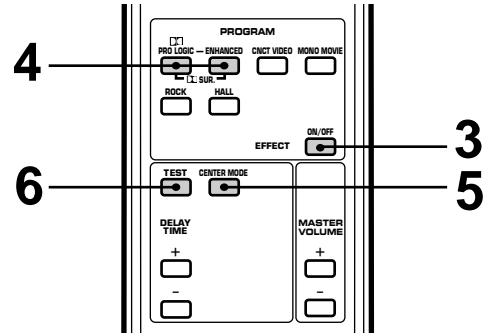
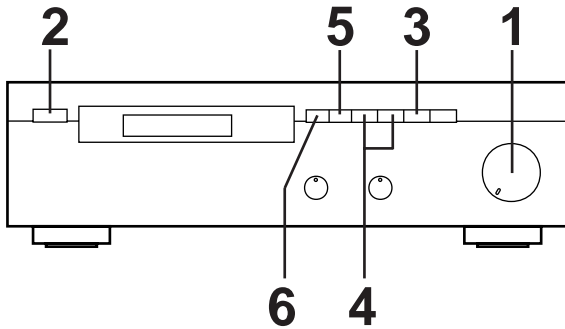

1

Set to the "∞" position.

2 Turn on the power of this unit and the amplifier etc.

3 Turn the DSP on, so that a DSP program name appears on the display.

4 Select the PRO LOGIC or PRO LOGIC ENHANCED mode, so that the corresponding name is illuminated on the display.

5 Select the center channel output mode according to your speaker configuration. (Refer to "SPEAKER CONFIGURATION" on page 5.)

On the feature of each mode, refer to the "Notes" shown below.

6

Flashes continuously.

- Notes**
- In step 5, when you select the center channel output mode, note the following.
 - For 5 speaker configuration)**
 - NORMAL:** Select this mode when you use a center speaker that is smaller than the front speakers. In this mode, the bass tone will be output from the front speakers.
 - WIDE:** Select this mode when you use the center speaker approximately same sized as the front speakers.
 - For 4 speaker configuration)**
 - PHANTOM:** Select this mode when you do not use the center speaker. The center sound will be output from the left and right front speakers.
 - If you will select a DSP program on the remote control transmitter, you can skip step 3. Pressing on a program selector button will turn the DSP on and select the corresponding program.

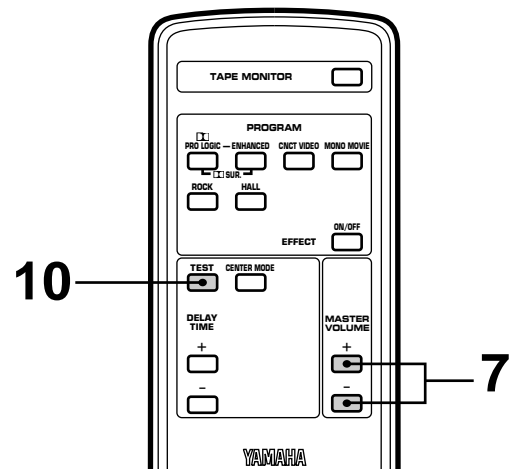
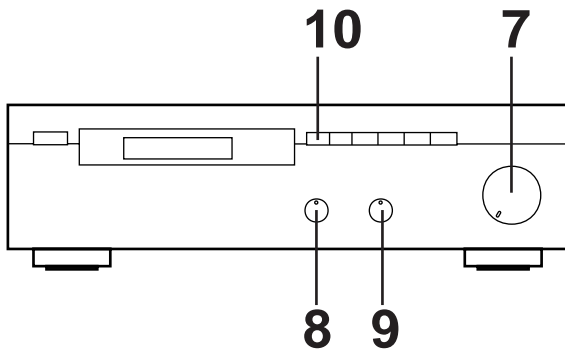

7 Turn up the volume.

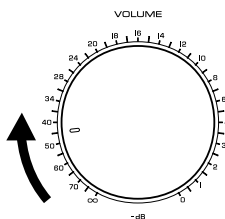

You will hear a test tone (like pink noise) from the left front speaker, then the center speaker, then the right front speaker, and then the rear speakers, for about two seconds each. The display changes as shown below.

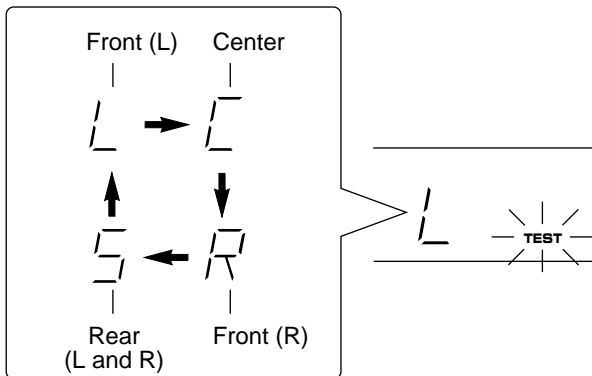

* The test tone from the left rear speaker and the right rear speaker will be heard at the same time.

8 Adjust the sound output level of the center speaker to be at the same level as that of the front speakers with the **CENTER LEVEL** control.

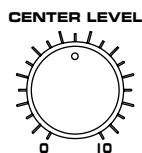

9 Adjust the sound output level of the rear speakers to be at the same level as that of the front speakers with the **REAR LEVEL** control.



10 Cancel the test tone.

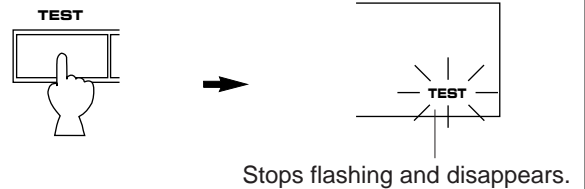

Notes

- Once you have completed these adjustments, you can adjust whole sound level on your audio system by using the **VOLUME** control (or the **MASTER VOLUME** keys on the remote control transmitter).
- If you use external power amplifiers, their volume controls may also be adjusted to achieve proper balance.
- In step 8, if the center channel mode is in the “**PHANTOM**” position, the sound output level of the center speaker cannot be adjusted. This is because in this mode, the center sound is automatically output from the left and right front speakers.
- If there is insufficient sound output from the center and rear speakers, you may decrease the front channel output level by setting the **FRONT LEVEL** switch on the rear panel to “-10 dB”.

USING DIGITAL SOUND FIELD PROCESSOR (DSP)



This unit incorporates a sophisticated, multi-program digital sound field processor, which allows you to expand and shape the audio sound field from both the audio and video sources, for a theater-like experience in the listening/viewing room.

This digital sound field processor has 6 programs; 4 programs for digital sound field processing and 2 programs for the Dolby Pro Logic Surround sound system (**DOLBY PRO LOGIC** and **DOLBY PRO LOGIC ENHANCED**). You can create an excellent audio sound field by selecting the suitable program and adding desired adjustments. In addition, when the **DOLBY PRO LOGIC** or **DOLBY PRO LOGIC ENHANCED** program is selected, the built-in automatic input balance control functions. This presents you the best surround condition without manual adjustment.

Description of Each Sound Field Program

The following list gives brief descriptions of the sound fields produced by each of the DSP programs. Keep in mind that most of these are precise digital recreations of actual acoustic environments. The data for them was recorded at the locations described using sophisticated sound field measurement equipment.

Note
The channel level balance between the left rear effect speaker and the right rear effect speaker may vary depending on the sound field you are listening to. This is due to the fact that most of these sound field recreations are actual acoustic environments.

PROGRAM	FEATURE
 PRO LOGIC	This program is effective for playback of sources encoded with Dolby Surround. The employment of the digital signal processing system improves crosstalk and transfers the sound source more smoothly and precisely, compared to the conventional type. A stable movie sound field is recreated.
 PRO LOGIC ENHANCED	This program is effective for playback of sources encoded with Dolby Surround. Enhancing the "Normal" Dolby Pro Logic, the DSP technology simulates the multi-surround speaker systems of a 35 mm film theater, thus widening the surrounded-sound field with greater presence.
CONCERT VIDEO	This program is effective for music videos and gives excellent depth and clarity for vocals. For opera, the orchestra and stage are ideally recreated, letting you feel as if you were in an actual concert hall.
MONO MOVIE	This program is designed specifically to enhance mono source programs. Compared to a strictly mono setting, the sound image created in this mode is wider and slightly forward of the speaker pair, lending an immediacy to the overall sound. It is particularly effective when used with old mono movies, news broadcasts and dialog.
ROCK CONCERT	This program is suitable for rock music. A big, powerful sound is reproduced lively and dynamically.
CONCERT HALL	In this program, the center seems deep behind the front speaker pair, creating an expansive, large hall ambience.

Description of Dolby Pro Logic Surround

 **DOLBY PRO LOGIC SURROUND:** This unit employs the Dolby Pro Logic Surround system. This system is similar to professional Dolby Stereo decoders used in movie theaters. By employing a four-channel system, the Dolby Pro Logic Surround system divides the input signals into four levels: the left and right main channels, the center channel (to characterize dialog), and the rear surround-sound channels (to characterize sound effects, background noise and other ambient noise).

Dolby Surround is encoded on the sound track of commercially available video cassettes and video discs as well. When you play a source encoded with Dolby Surround on your home video system, the Dolby Pro Logic Surround system in this unit decodes the signal and feeds the surround-sound effects. The Dolby Pro Logic Surround mode may not be always effective on video sources not encoded with Dolby Surround.

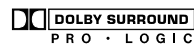

Manufactured under license from Dolby Laboratories Licensing Corporation. Additionally licensed under Canadian patent number 1,037,877. "Dolby", "Pro Logic", and the double-D symbol are trademarks of Dolby Laboratories Licensing Corporation.

To play a source with the digital sound field processor

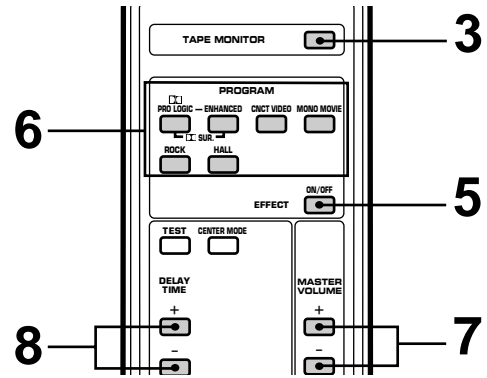
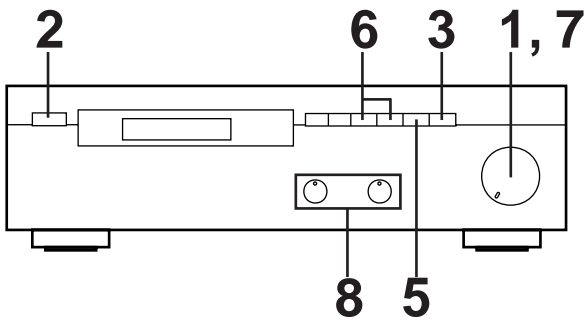

1

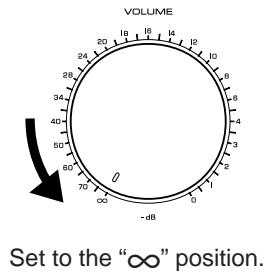

2 Turn the power on.

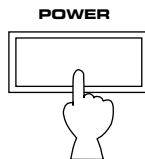

3 Select a source using the input selector on the integrated amplifier etc.

* To select a tape deck connected to this unit's TAPE terminals, press the **TAPE MONITOR** switch so that "TAPE MONITOR" lights up on the display. (Otherwise, press this switch to turn it off.)

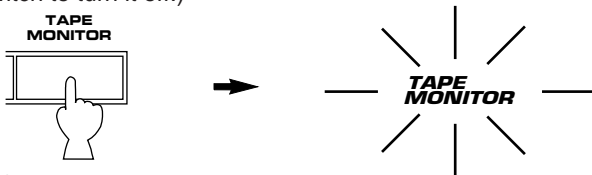

Note

If this unit is connected to the TAPE REC OUT terminals of the integrated amplifier etc., the following operations are needed.

- If your amplifier has the REC OUT selector which is independent of the input selector;
 1. Set the input selector to the position (AUX, TAPE, etc.) which corresponds to the amplifier's terminals connected to this unit's FRONT OUT terminals.
 2. Select the source to be input to this unit using the REC OUT selector.
- If your amplifier does not have the REC OUT selector which is independent of the input selector;
 1. Set the TAPE monitor switch on the amplifier to on.
 2. Select the source to be input to this unit using the input selector.

4 Play the source.

5 Turn the DSP on, so that a DSP program name appears on the display.

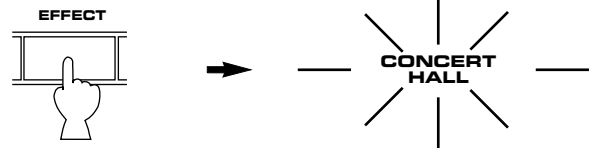

6 Select a desired program suitable for the source.

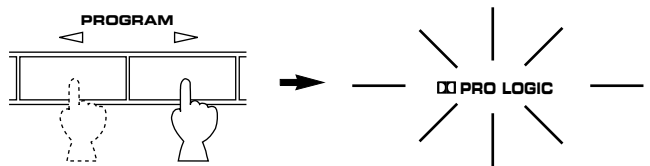

The corresponding indicator will light up.

7

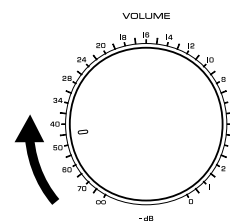

Adjust to the desired output level.

8 If desired, adjust the delay time and the output level of each speaker. (For details, refer to the corresponding descriptions on page 14 and 15.)

To obtain the best performance of this unit:

If the connecting method of your components is **A** or **C** shown on pages 6–7, set the volume control on the integrated amplifier or control amplifier to about the halfway position between the min. and max.

Notes

- If you prefer to cancel the DSP, press the **EFFECT** switch. The sound will be the normal 2-channel stereo without surround sound effect.
- When **CONCERT VIDEO, MONO MOVIE, ROCK CONCERT** or **CONCERT HALL** is selected, no sound is heard from the center speaker.

- When a monaural sound source is played with **DOLBY PRO LOGIC** or **DOLBY PRO LOGIC ENHANCED**, no sound is heard from the front speakers and the rear speakers. Sound is heard only from the center speaker. However, if the center channel mode is in **PHANTOM**, the front speakers output the sound of the center channel.
- When this unit's Dolby Pro Logic Surround system is used, if the main-source sound is considerably altered by overadjustment of the BASS or TREBLE controls on the integrated amplifier etc., the relationship between the center and rear channels may produce an unnatural effect.
- If the connected external amplifier has a built-in surround sound or ambience circuitry, be sure that the surround or ambience circuitry on that amplifier is off while you are using this unit's Dolby Pro Logic Surround system.

Adjustment of the CENTER LEVEL

If desired, you can adjust the sound output level of the center speaker even if the output level is already set in “**SPEAKER BALANCE ADJUSTMENT**” on page 11.

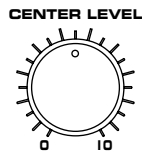

- If the digital sound field program **CONCERT VIDEO, MONO MOVIE, ROCK CONCERT** or **CONCERT HALL** is selected, this adjustment is useless.
- Once the output level is adjusted, the level value will be the same in the **DOLBY PRO LOGIC** and **DOLBY PRO LOGIC ENHANCED** programs.
- If no program is used, this adjustment is useless.

Adjustment of the REAR LEVEL

If desired, you can adjust the sound output level of the rear speakers even if the output level is already set in “**SPEAKER BALANCE ADJUSTMENT**” on page 11.



- Once the output level is adjusted, the level value will be the same in all the digital sound field programs.
- If no program is used, this adjustment is useless.

Adjustment of DELAY TIME

You can adjust the time difference between the beginning of the source sound and the beginning of the effect sound with the **DELAY TIME** keys.

The **DELAY TIME** keys are effective with all programs.

By applying more or less delay, sound effects, background noise, and ambient noise coming at you from the rear speakers can be enhanced or subdued for extra effect.

1. **PRO LOGIC** : from 15 to 30 milliseconds
(Preset value: 20 milliseconds)
2. **PRO LOGIC ENHANCED** : from 15 to 30 milliseconds
(Preset value: 20 milliseconds)
3. **CONCERT VIDEO** : from 1 to 100 milliseconds
(Preset value: 25 milliseconds)
4. **MONO MOVIE** : from 1 to 100 milliseconds
(Preset value: 25 milliseconds)
5. **ROCK CONCERT** : from 1 to 100 milliseconds
(Preset value: 15 milliseconds)
6. **CONCERT HALL** : from 1 to 100 milliseconds
(Preset value: 30 milliseconds)

- By continuously pressing “+” or “-” key, the value changes continuously. However, the value stops changing momentarily at the preset point.

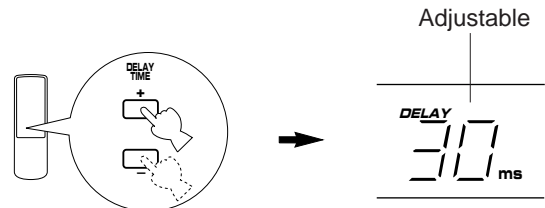

Notes

- Adding too much delay will cause an unnatural effect with some sources. Experiment with the **DELAY TIME** keys to create the effect that you find most suitable.
- The values of the **DELAY TIME** you set the last time will remain memorized even when the power of this unit is off. However, if the power cord is kept disconnected for more than one week, these values will be automatically changed back to the original factory settings.

NOTES ABOUT THE REMOTE CONTROL TRANSMITTER

Battery installation

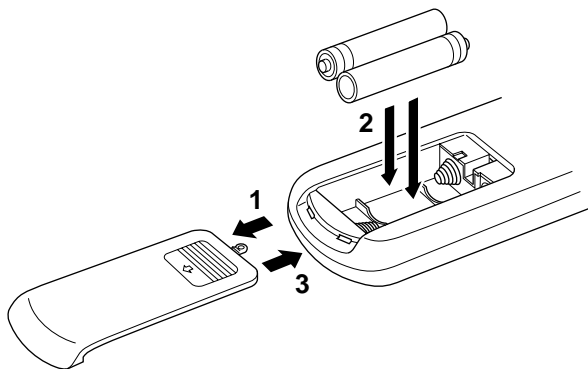

Battery replacement

If you find that the remote control transmitter must be used closer to the main unit, the batteries are weak. Replace both batteries with new ones.

Notes

- Use only AA, R6, UM-3 batteries for replacement.
- Be sure the polarities are correct. (See the illustration inside the battery compartment.)
- Remove the batteries if the remote control transmitter will not be used for an extended period of time.
- If batteries leak, dispose of them immediately. Avoid touching the leaked material or letting it come in contact with clothing, etc. Clean the battery compartment thoroughly before installing new batteries.

Remote control transmitter operation range

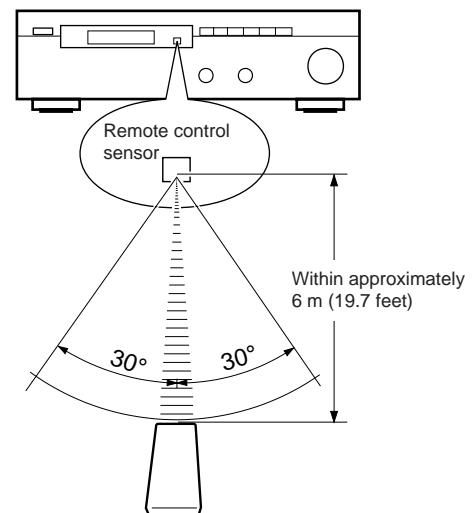

Notes

- There should be no large obstacles between the remote control transmitter and the main unit.
- If the remote control sensor is directly illuminated by strong lighting (especially an inverter type of fluorescent lamp etc.), it might cause the remote control transmitter not to work correctly. In this case, reposition the main unit to avoid direct lighting.

TROUBLESHOOTING

If the unit fails to operate normally, check the following points to determine whether the fault can be corrected by the simple measures suggested. If it cannot be corrected, or if the fault is not listed in the SYMPTOM column, disconnect the power cord and contact your authorized YAMAHA dealer or service center for help.

SYMPTOM	CAUSE	REMEDY
The unit fails to turn on when the POWER switch is pressed.	Power cord is not plugged in or is not completely inserted.	Firmly plug in the power cord.
No sound.	Incorrect output cord connections.	Connect the cords properly. If the problem persists, the cords may be defective.
The sound suddenly goes off.	The protection circuit has been activated because of short circuit etc.	Turning the unit off and then on will reset the protection circuit.
Only one side speaker outputs the sound.	Incorrect cord connections.	Connect the cords properly. If the problem persists, the cords may be defective.
Sound "hums".	Incorrect cord connections.	Firmly connect the audio plugs. If the problem persists, the cords may be defective.
The volume level cannot be increased, or sound is distorted.	The power to the component connected to the REC OUT terminals of this unit is off.	Turn the power to the component on.
No sound from the rear speakers.	The rear effect sound output level is set to 0.	Turn up the sound output level with the REAR LEVEL control.
	The monaural sound source is played in DOLBY PRO LOGIC or DOLBY PRO LOGIC ENHANCED mode.	Select another program suitable for the monaural sound source.
No sound from the center speaker.	The center sound output level is set to 0.	Turn up the sound output level with the CENTER LEVEL control.
	The center channel mode is in PHANTOM mode.	Select NORMAL or WIDE.
	Incorrect sound field program selection.	Select the appropriate program.
	No sound field program is selected.	
Left rear and right rear channels not balanced in certain digital sound field programs.	This is normal operation and is an exact duplication of the actual data which was measured for that particular hall etc.	
The sound field cannot be recorded.	It is not possible to record the sound field on a tape deck connected to this unit's TAPE REC OUT terminals.	
Noise from nearby TV or tuner.	This unit is too close to the affected equipment.	Move the unit further away from the affected equipment.
The remote control transmitter does not work.	Direct sunlight or lighting (of an inverter type of fluorescent lamp etc.) is striking the remote control sensor of the main unit.	Change the position of the main unit.
	The batteries of this remote control transmitter are too weak.	Replace the batteries with new ones.

SPECIFICATIONS

Minimum RMS Output Power Per Channel
 Center (1 kHz 0.1% THD 8Ω) 60W
 Rear (1 kHz 0.7% THD 8Ω) 15W+15W
 Input Sensitivity/Impedance (FRONT OUT 1V)
 INPUT and TAPE PB 150 mV/47 kΩ
 Output Level/Impedance
 FRONT, REAR and CENTER OUT 1V/4.7 kΩ
 LOW PASS (EFFECT OFF) 4V/4.7 kΩ
 Frequency Response (20 Hz – 20 kHz)
 FRONT OUT (EFFECT OFF) 0±1 dB
 Signal-to-Noise Ratio (IHF-A Network)
 INPUT (Input Shorted, EFFECT OFF) 95 dB

Channel Separation Vol –30 dB
 (Input 5.1 kΩ Shorted, EFFECT OFF)
 1 kHz/10 kHz More than 65 dB/50 dB
 Filter Characteristics
 LOW PASS (fc = 200 Hz) 6 dB/oct.
 Power Consumption
 [U.S.A., Canada and General models] 120W
 [Australia, U.K. and Europe models] 135W
 AC Outlet
 1 SWITCHED OUTLET 100W max.
 Dimensions (W x H x D) 435 x 126 x 298 mm
 (17-1/8" x 4-15/16" x 11-3/4")
 Weight 6 kg (13 lbs. 3 oz.)

Specifications are subject to change without notice.